

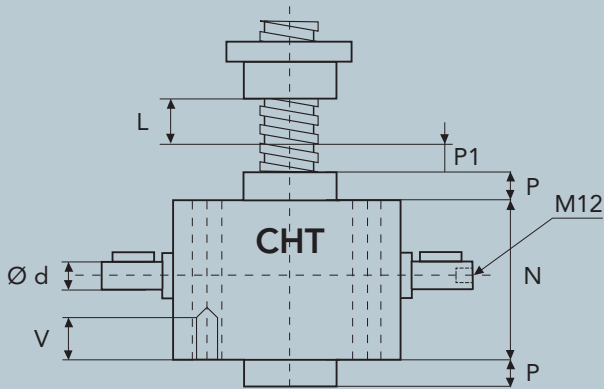

SERIES CHS 10 RS

ROTATING SCREW

HEAVY LINE



L = CORSA

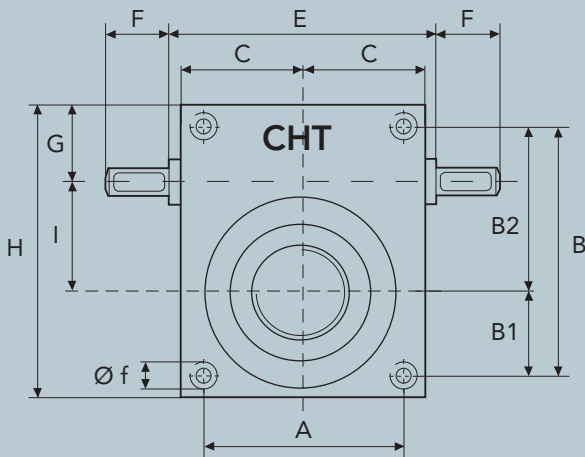

BRONZE NUT

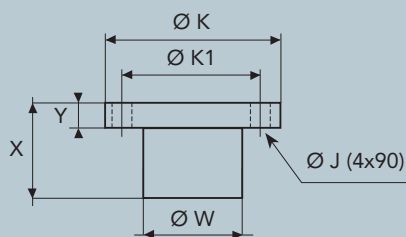

	X	Y	Ø W	Ø K	Ø K1	Ø J
CHS10	135	45	150	230	190	20

CONFIGURATION

MOTORS ADAPTORS FLANGES

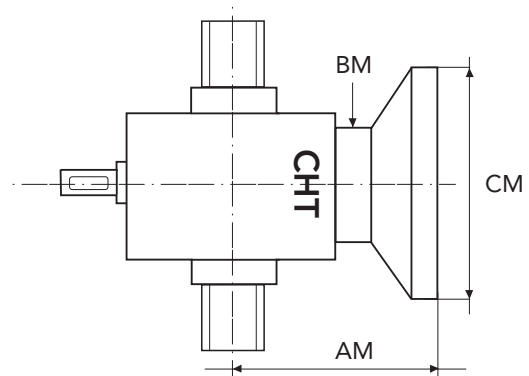

FOR SPECIAL EXECUTION
please consult our technical DPT

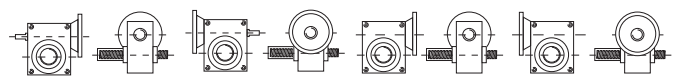

M1

M2

M3

M4

SERIES CHS 10 TS - 40000 daN · TPN 100x12